

FMC SERIE QUATTRO

CNC Machining centre with 4 controlled axes

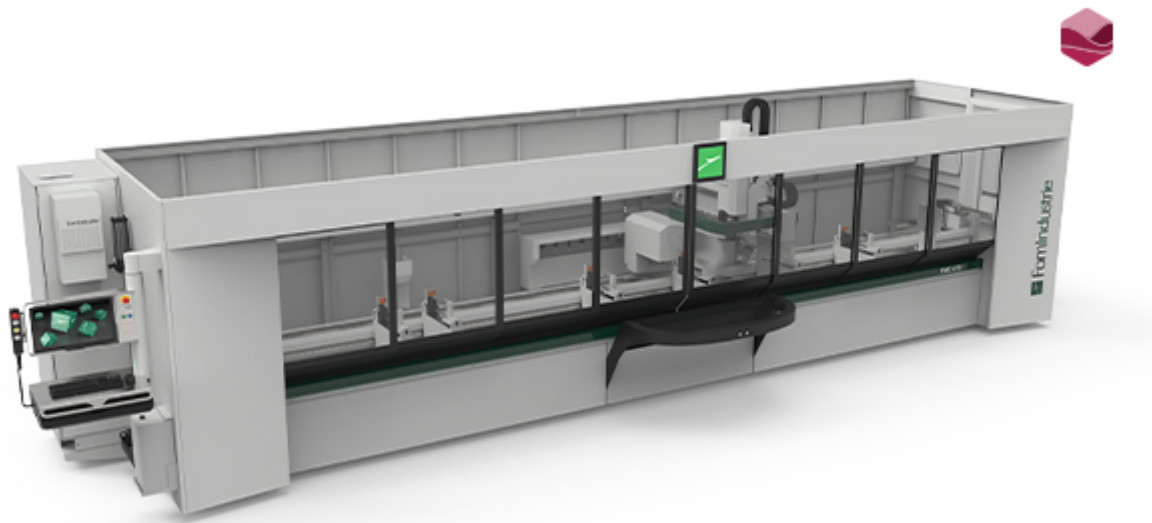

The FMC440/FMC470 machining centres with 4 controlled and interpolating axes have been designed to carry out drilling and milling operations on aluminium or steel profiles (max thickness 3 mm). The following functions can be activated on request: “machining with interpolating axes” (3D Custom Milling Module), “multi-piece machining”, “pendular machining” or “multi-piece and pendular machining” with the ability to select numerous vice/stop configurations.

Overall dimensions and weight

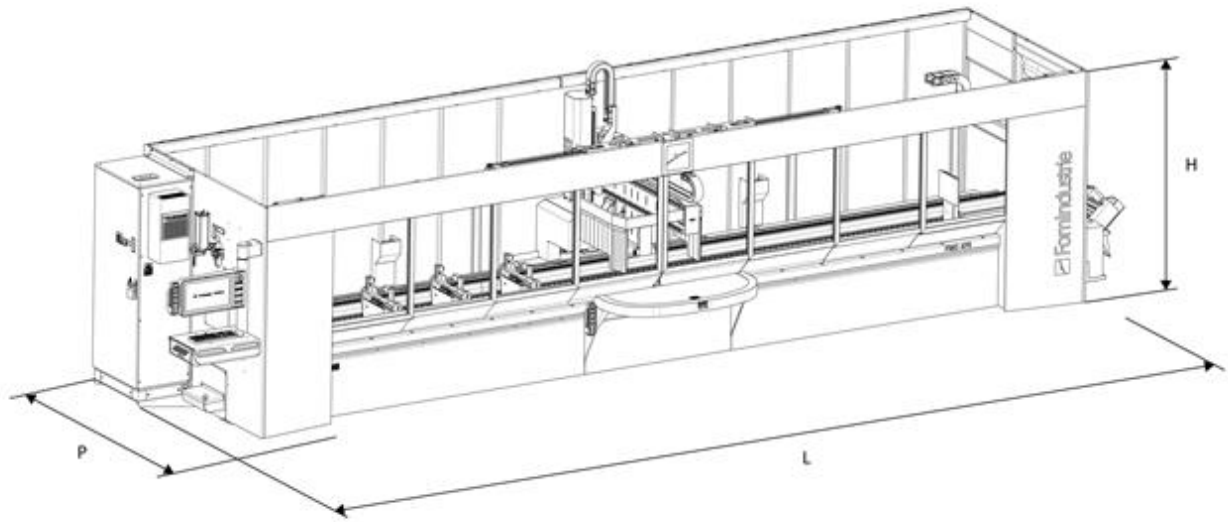

Version	L (mm)	P (mm)	H (mm)	Kg
FMC 440	7165	2440	2600	4000
FMC 470	10165	2500	2600	5600
FMC 440	8060 (with conveyor belt)	2730 (with front bench)	2600	4600 (with conveyor belt)
FMC 470	10720 (with conveyor belt)	2730 (with front bench)	2600	6400 (with conveyor belt)
FMC 440 CZ	7165	2440	2690	4230
FMC 470 CZ	10165	2500	2690	6000
FMC 440 CZ	8060 (with conveyor belt)	2730 (with front bench)	2690	4830 (with conveyor belt)
FMC 470 CZ	11075 (with conveyor belt)	2730 (with front bench)	2690	6800 (with conveyor belt)

Power supply	Total power installed	Air consumption for work cycle	Working pressure
3F - 380÷415 V - 50 Hz	16,6 kW	140 NL/cycle	7 bar



Technical characteristics

Structure - FOM PATENT

The structure consists of a base and a column sized to guarantee exceptional stability and precision during machining. The patented configuration of the base minimises the deposit of machining residues. On request, a chip conveyor can be installed in the base.

Axes movement

The independent axis are controlled by brushless servomotors by means of:

- Pinion with helical teeth and rack for axis X (longitudinal) and axis Y (transversal)
- High precision ground recirculating ball screw and preloaded lead nut for axis Z (vertical)

Absolute encoder systems applied to all the axes make the zeroing (homing) operation at machine start-up superfluous.

Centralised automatic lubrication system

A system automatically sends lubricant to the sliding and movement elements at preset intervals without stopping the machine. The parts lubricated in particular are:

Axis X: 4 slides of the linear guides and rack.

Y axis: 4 slides of the linear guides and rack.

Z axis: 4 slides of the linear guides recirculating ball screw nut

A message displayed on the monitor informs the operator when the minimum level of lubricant has been reached in the tank.

A device is also supplied as standard to carry out manual greasing when necessary.

Machining head

The machining head allows machining operations to be carried out on 3 faces of the profile and on 2 ends using angular head units and blades. The tilting axis consists of a rotating head of high-precision and rigidity driven by a zero play gear drive and brushless motor.

Electrospindle

The 7 kW liquid-cooled electrospindle provides power and reliability under all operating conditions. An 11 kW 20.000 rpm electrospindle for particularly heavy machining operations is available on request.

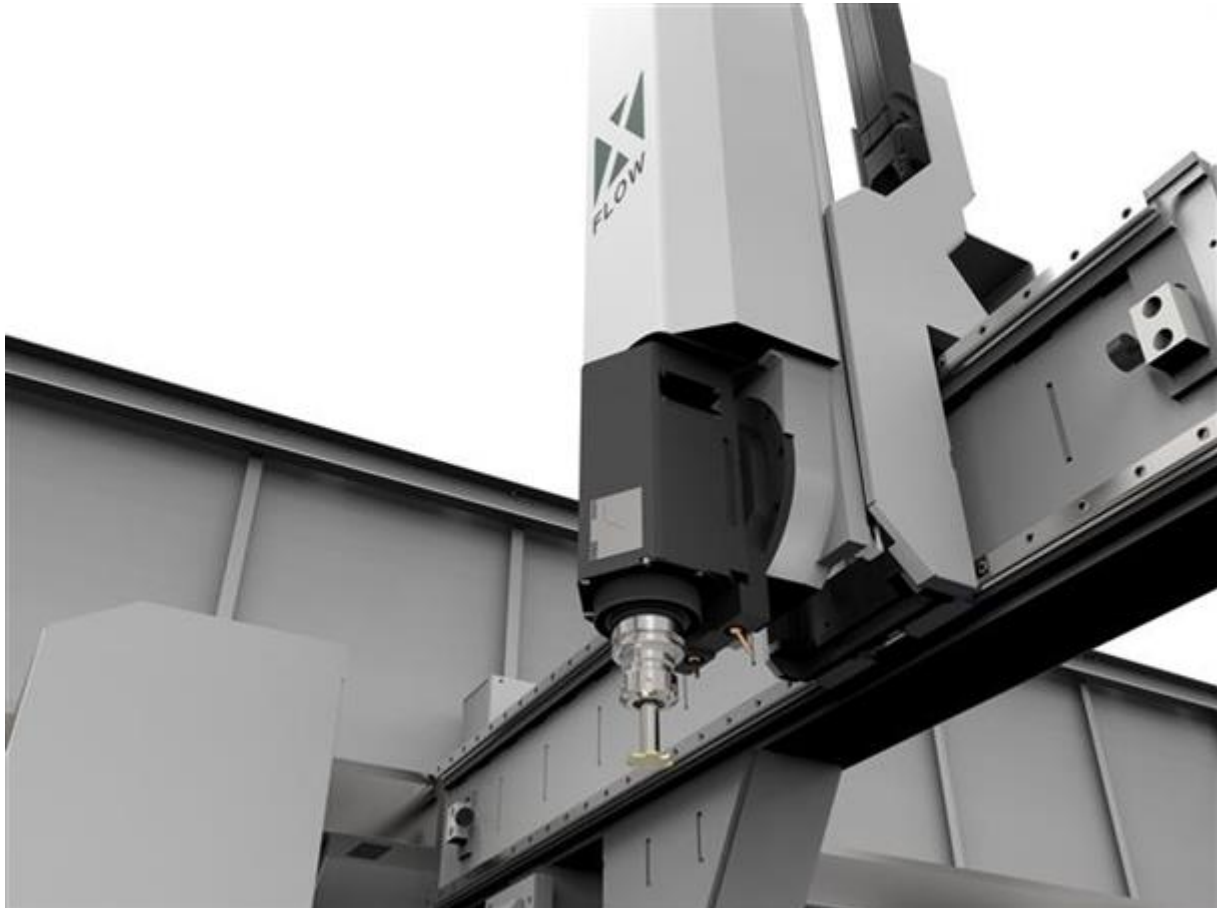

Mt (Nm)

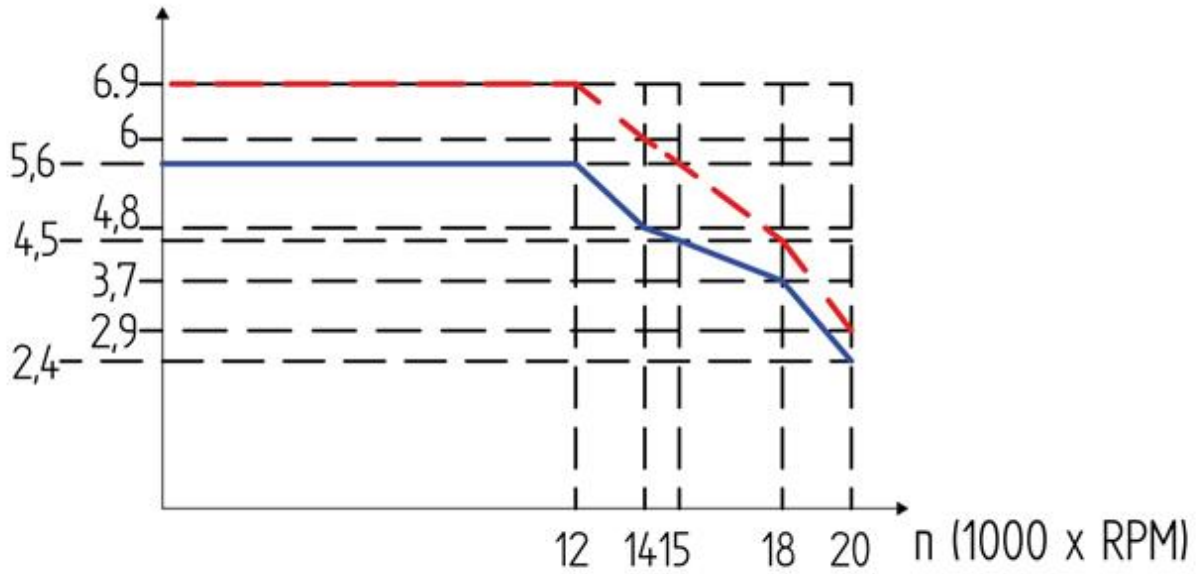

P (kW)

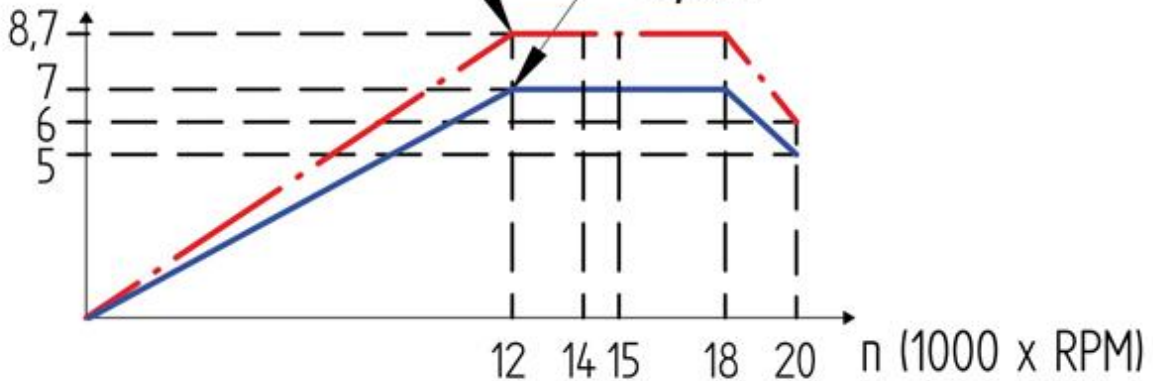

Duty / Servizio S6 - 40%

Duty / Servizio S1

Technical specifications:

Tool-holder type	HSK F63
Weight	20 Kg
Direction of rotation	clockwise and counterclockwise
Working position	↕ ↔
Bearings lubrication	Grease
Motor coolant	Fluid
Motor classification	Three-phase asynchronous
Rated power	7 kW
Rated torque	5,6 Nm
Rated speed	14000 RPM
Max speed	20000 RPM
Insulation class	F
Index protection	54

Available optional:

SW module for rigid tapping

	7 kW or 11 kW electrospindle
Rigid tapping on aluminium	Max M16 depth 28 mm
Rigid tapping on steel	Max M10 depth 3 mm

Tools lubrication

The tools are lubricated by a pressure spray (minimum quantity lubrication). The lubricant used is pure oil or, on request, oil emulsion and a dedicated tank (mist type cooling lubrication).

X FLOW - FOM PATENT

Used to adjust and optimise the lubricant flow direction automatically during tool change operations without manual intervention by the operator.

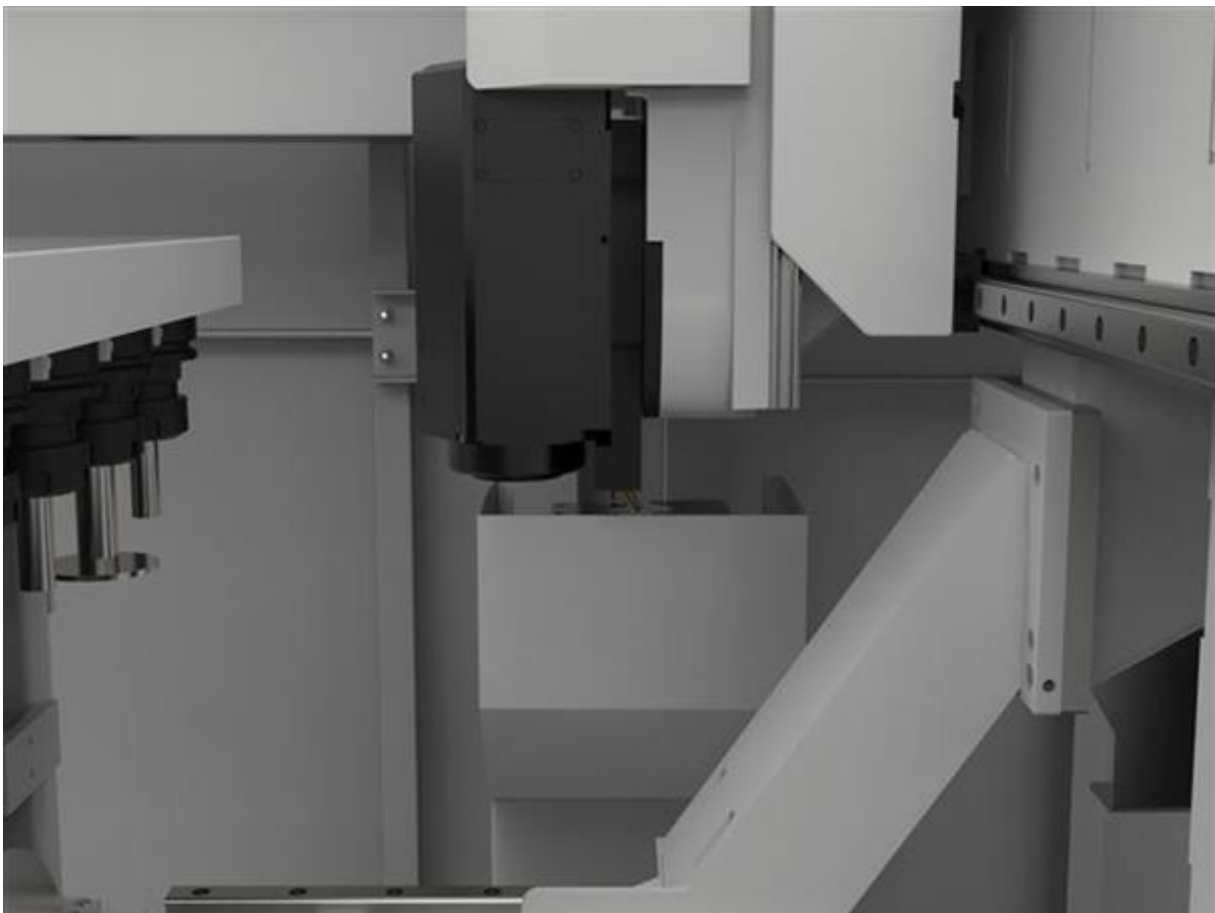

Tool magazine

The tool magazine is located on the carriage (PIC. 1) to allow extremely reduced machining cycles. It has 9 positions that allow up to two angular head units to be housed. On request, a device for checking the integrity and for measuring the length of the tool can be fitted on the tool magazine in order to guarantee precise machining always. A further 8 tools can be housed in the optional supplementary tool magazine (PIC. 2) mounted in a fixed position at the centre of the base. Refer to the attached magazine configuration options.

PIC. 1



PIC. 2

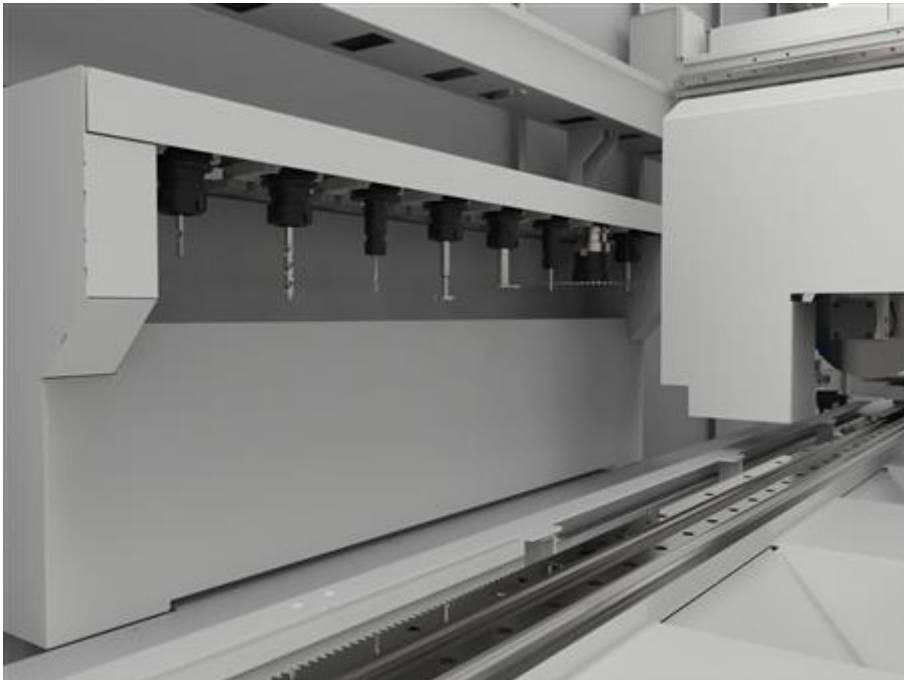

Work area organisation

Vices

The vices are in cast aluminium and slide along the X-axis on linear guides. The linear guides also ensure the closure of the cast iron jaw. The reduced dimensions lessen the need to reposition the vices and guarantee a tight grip very close to the actual machining. Each vice has a centre roller to facilitate the loading of the profiles and prevent chips depositing. Automatic positioning (via the machining head) is standard, while an independent positioning system using an additional axis is available on request. The position of the jaw and the vice pad can be quickly adjusted without using tools. The jaw is adjustable to predefined positions, while the vice pad is adjustable to all positions to ensure ideal clamping under all working conditions. Each extra clamping vice is fitted with lowered pads that allow the clamping capacity and working areas to be extended.



Stops

It is provided with a left side fixed position pneumatically reclining stop. On request, a second fixed and reclining stop on the right side is available, which is also useful for two-phase machining of profiles of length longer than the travel of the CNC machining centre. Also available on request are two stops with controlled positioning.



Device to measure profile length (on request)

Located on board the axis X. The machining positions are updated automatically after measurement.

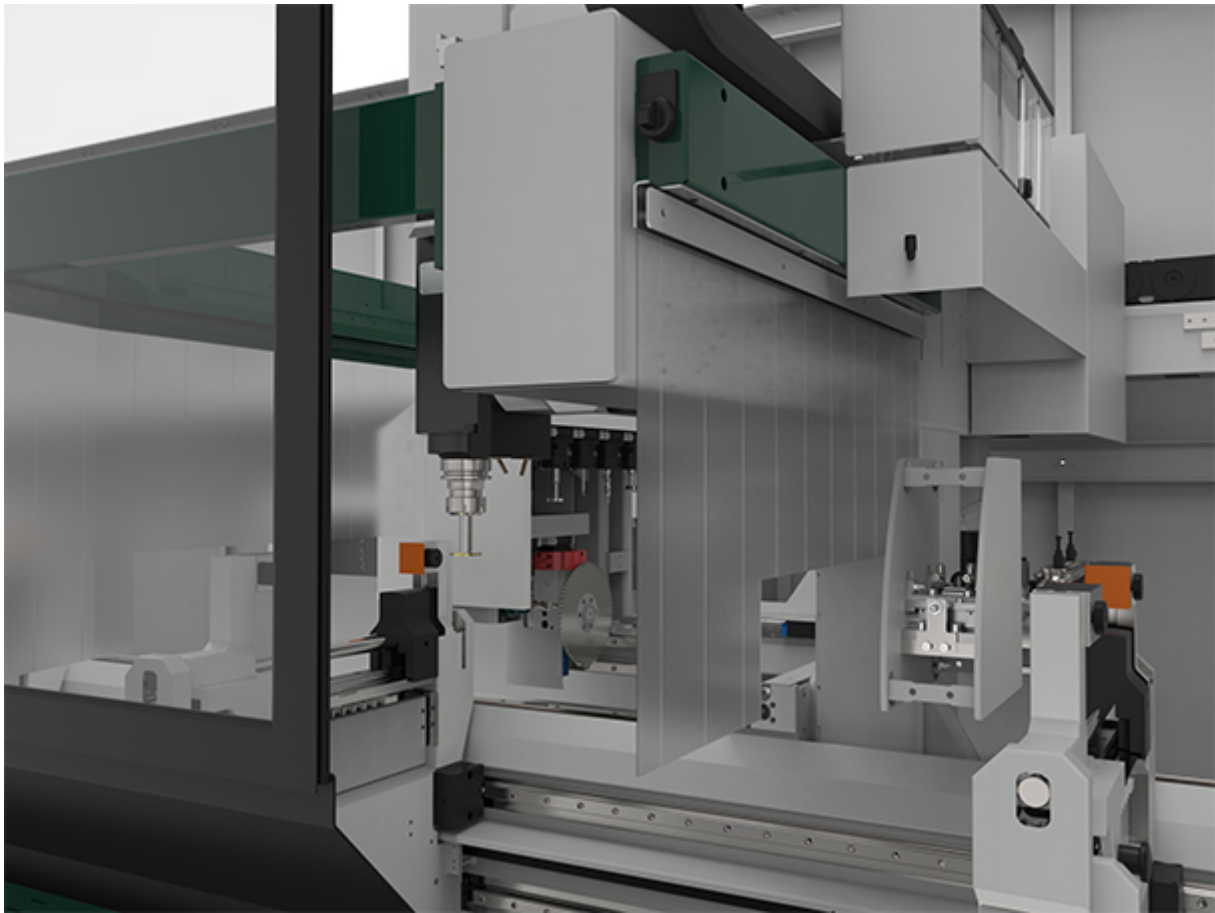

X PAL - FOM PATENT (on request)

Multifunction LED bar that assists the operator when using the machine and loading the bars. Allows additional positioning with respect to that provided by the stops. Signals the progress of the machining cycle.



Possible work area configurations:

See attached graphic illustration of the working area configurations

- SINGLE WORKING AREA 2 PIECES AND OVERSIZED MACHINING
- SINGLE WORKING AREA 2 PIECES MACHINING AND OVERSIZED MACHINING WITH X PAL (On FMC 470 it is possible to machine up to 5 pieces by adding 3 pairs of vices to this configuration)
- PENDULAR (2 working areas, 2 pieces) AND OVERSIZED PROFILES MACHINING
- PENDULAR (2 working areas, 2 pieces) AND OVERSIZED PROFILES MACHINING WITH X PAL
- MULTI-PIECE PENDULAR (2 working areas, 4 pieces) AND OVERSIZED PROFILES MACHINING
- MULTI-PIECE PENDULAR (2 working areas, 4 pieces) AND OVERSIZED PROFILES MACHINING WITH X PAL

Protection and safety devices

The CNC machining centre bears the CE symbol in compliance with the content of Directive 2006/42/CE (Machine Directive). The design and construction of the machining centre complies with the safety regulations in force in the European Union and in the main industrialised countries (USA, Canada, etc). In particular, for the European Union market the following legal provisions are complied with: Directive 2006/42/CE (Machine Directive), Directive 2014/30/UE (EMC). The machining centre is also equipped with special safety devices designed to comply with the relevant product standards and the regulations on health and safety in the workplace:

Perimeter guard system around the machine, with interlocked mobile doors and central locking system, that guarantees maximum visibility during machining and accessibility during maintenance.

Luminous status bar (Fom Industrie Logo) incorporated in the guard system, the colour of which signals the machine status.

Stopped shaft safety module that enables the doors to be opened under safe conditions.

Safety PLC.

Protective strips on mullion that hosts the electrospindle (only for CNC machining center with "pendular machining" operating mode)

Front protective bench that guarantees a safety distance between the operator and the column (only for machining centres with "pendular machining" operating mode).



The electrical system has been engineered in compliance with the provisions contained in European Union directives 2006/95/CE (LVD), 2004/108/CE (EMC) and conforming to the applicable standards governing the safety of electrical systems (EN 60204-1, EN 61000-6-2 and EN 61000-6-4). Special care has been given to the provision of emergency cables and to the system for activating and resetting them. If any faults occur, the operator is alerted by light signals and messages on the monitor. In the event of faults or breakdown, The protection devices inside the panel are designed to prevent injury to persons and/or damage to the machining centre itself.

If for any reason the interaction between the CNC machining centre and the environment in which it is installed contravenes any of the above mentioned conditions, it will be essential to agree with the purchaser a comprehensive solution for achieving the necessary safety conditions so that the purchaser can make the area designated for installing the machining centre suitable and safe.

Movable control console

Attached to the protection cabin and used to execute commands and run programs. 24" display

Control pushbutton panel

Standard and ergonomic, allows the machine to be controlled from any position during machining.



PC comprising of:

- 128 GB SSD
- Gigabit RJ45 network Interface
- 8 GB RAM
- Windows 10 operative system
- USB ports
- 3-year international "on site" warranty

LOLA



LOLA is the cloud based IoT platform created by Fom Industrie for Industry 4.0, with the aim of monitoring and increasing productivity and efficiency.

The LOLA web application can be accessed via browser (Safari, Chrome), on a PC or mobile device.

LOLA receives data from the FOM Industrie machine tool, via internet connection, and generates statistics that can be consulted by the end user, regarding:

- productivity
- efficiency
- diagnostics
- scheduled, periodic and predictive maintenance
- alarms, push notifications and predictive warning

Characteristics

- Developed in responsive technology, which adapts the graphic layout to the device being used.
- Plant Manager for grouped display of your machines and alarms, based on factory or manufacturing department
- Timezone/DayTimeSavingLight Management
- LOLA application users (unlimited, until expiry of the license) with two privilege levels, to define criteria for hierarchical content visibility.
- Various machines can be associated with a single operator, or several operators can be associated with various machines.
- LOLA is now available in 5 languages: Italian, English, French, Spanish, German

LOLA allows control of the following with a single glance:

- machine status and efficiency
- machining statistics
- diagnostics for key machine components (e.g. electrospindles, tools, sensors..)
- alarms and warnings log for the individual machine or the factory (*for FOM LOLA compliant machines)
- push notifications for periodic and predictive maintenance events. Log of operations confirmed in LOLA.

The data indicate every time a key component is coming to the end of its lifecycle, so that it is possible to plan the replacement operation with the FOM service department or independently, thus minimising machine stoppages.

Export of data for integration with MES systems

With the additional Lola Exporter license it is possible to export the data collected by LOLA in CSV format locally, allowing subsequent integration with the most common MES systems

FST CAM 4 graphic interface

Graphic interface based on the Windows operating system for planning the machining operations and the pieces which automatically generates the CNC program that can be executed by the machining centre.

Program features:

- Display of the workpiece and machining operations in a CAD 3D environment
- Profile cross-section display in DXF format
- 3D display of tool archive
- Machining optimizations
- Dynamic display of the machining operations
- Graphic display of the working area
- Simplified management of machining process sequence
- Display of technical features of pieces and tools
- Graphic user interface
- Parametric machining management
- Creation of repeated machining operations
- Automatic calculation of optimal vice positioning
- Machining lists management
- Graphic interface for numeric control management

Optionals:

- Licence for FST CAM 4 program for office
- Additional licence for FST CAM 4 program for office
- FSTCAM4 module to design and manage special clamping operations (PIC. 3)
- "Clock" time calculation module program user license for FST CAM 4
- SOLID PLUS software licence (3+1 or 4 axis CNC machining centres)
- SOLID PLUS additional software licence (3+1 or 4 axis CNC machining centres)
- Licence for FST STATISTICS C4 program
- 2D custom milling Module for FST CAM 4
- 3D custom milling Module for FST CAM 4
- SW licence FSTConverter for data import in NCX format
- Module for rigid tapping and chase tapping
- Flow drilling management
- Data import software in accordance to FOM protocol + Wireless optical bar code and QR code reader
- Data conversion driver

PIC. 3

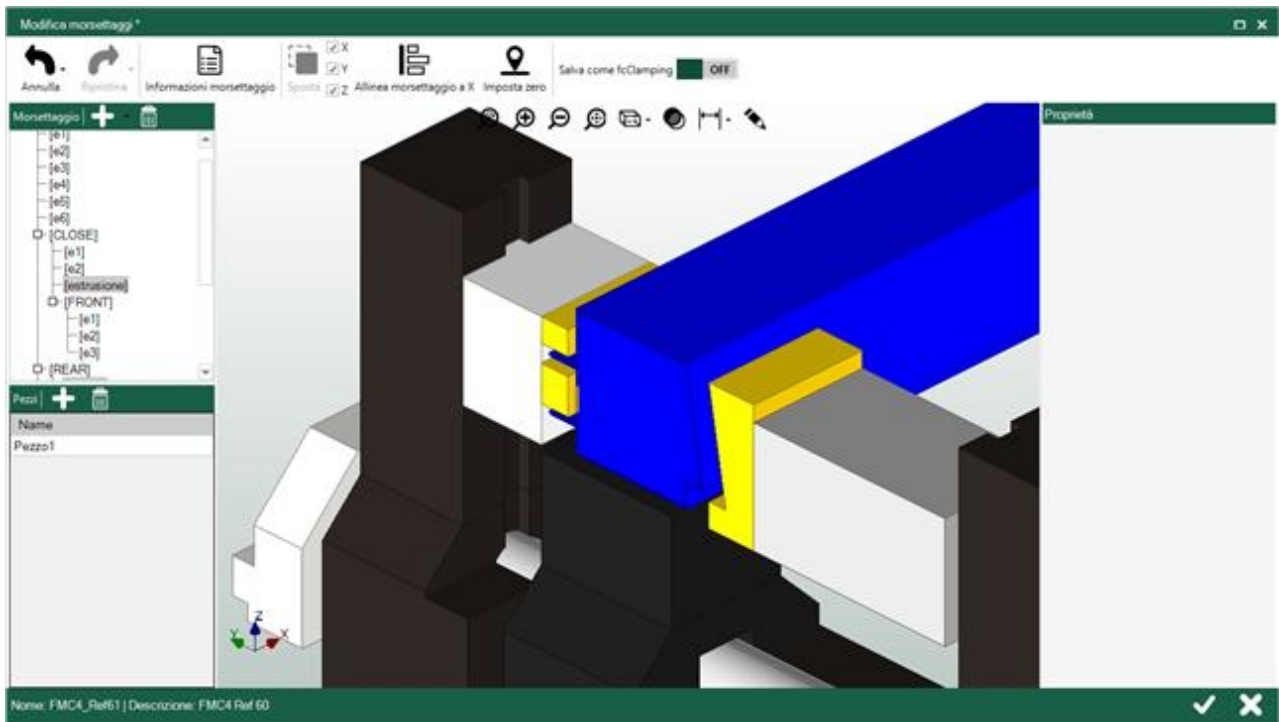

Remote Assistance

Used to check the machine data, the user programmes, the input/output signals and system variables in real time, providing a rapid solution to problems and a drastic reduction in machine stoppage. Thanks to remote assistance it is also possible to install updated software versions. The machining centre is enabled for this type of service. The duration of the service is limited to the machining centre warranty period.

Maintenance equipment

The following are supplied with the machining centre:

Tool holder locking device for insertion/removal of tools

Set of wrenches

Turnkey System

FOM INDUSTRIE not only offers its Clients a machine tool, but also a "turnkey" productive system to solve all of the problems involved in production. The company's experience is at the client's disposition to optimise the relationship between machining centre performance and the technological machining requirements, the service relies on:

A CAD-CAM system for creating a project which provides for piece design, automatic creation of the program and simulation of the machining operations

A vast archive of projects created for companies operating in important industrial sectors (automotive, railways, naval, furniture, transport, aeronautic, textile)

Facilitated contacts with the most important and qualified suppliers of tools and equipment

Documentation

Every machining centre comes with a printed copy of the following documentation: User and maintenance manual, complete with electric and pneumatic diagrams; Control unit user's manual. The manuals are available in Italian and English

Standard configuration:

- Liquid-cooled electrospindle 7 kW, 20.000 rpm (HSK-F63)
- 9 location tool magazine on head (HSK-F63)
- No. 2 pairs of pneumatic vices with positioning through the travelling column
- N° 2 pairs of low profile clamping pads
- Left retractable fixed pneumatic stop
- Minimum quantity lubrication (MQL) with pure oil
- Central automatic greasing system and device for manual greasing
- Chip and waste collection tank in base
- Perimeter guard system with automatically opening, front retractable doors
- X FLOW (Automatic orientation of lubrication nozzles)
- Equipment for machine lifting with bridge crane
- Control equipment: POWER-D
- Movable control console
- 24" Display
- Licence for FST CAM 4 program
- Collective FST CAM 4 training course at FOM Industrie (excluding transfer costs)
- Potentially Industry 4.0 subsidizable asset

Technical specifications:

Working area with direct tool L=100 spindle end and with tools L=60 on 2-output angular unit		
Axis X (FMC 470)	top face only	mm 7158
Axis X (FMC 470)	top face + ends	mm 7000
Axis X (FMC 440)	top face only	mm 4163
Axis X (FMC 440)	top face + ends	mm 4000
Axes Y and Z	for machining on 3 faces of profile	mm 250 x 270
Axes Y and Z	for machining on 2 faces of profile with lowered vice pads	mm 300 x 270
Axis A		-15° ÷ +195°

Dynamic performance		
Axis X	Speed	m/min 100
Axis Y	Speed	m/min 66
Axis Z	Speed	m/min 38
Axis A	Speed	°/min 7800
Axes X	Acceleration	m/s ² 4
Axis Y	Acceleration	m/s ² 4
Axis Z	Acceleration	m/s ² 3

Profile positioning and locking		
Vices with automatic positioning along the X-axis (longitudinal) through the travelling column		n. 4 as standard
Max number of vices (FMC 470)		10
Max number of vices (FMC 440)		8
Transformation of standard vices to vices with independent positioning		optional
Vice pair with positioning along the X-axis (longitudinal) through the travelling column		optional
Pair of vices with independent positioning		optional
Automatically reclining fixed stop		n. 1 standard + 1 optional
Pair of independent driven mobile stops for multi-piece machining		optional
Multi-piece in Y		optional
SW adjustment of the vice pressure		optional
Pendular machining + second X FLOW + pneumatic profile stop on right side		optional
Oversized profile machining + guard tunnel		optional
Device to measure profile length		optional

Electrospindle		
7 kW 20.000 rpm electrospindle		standard
11 kW 20.000 rpm electrospindle		optional
SW Module for rigid tapping		optional
Cooling		Liquid
Tool coupling		HSK – F63

Lubrication of mechanical components		
Automatic lubrication of straight guide blocks and recirculating ball screw lead screws		standard

Tool magazine

9-Position tool magazine mounted on the head		standard
8-Position tool magazine fixed to the base		optional
Maximum blade diameter in the magazine (head mounted)	mm	230
Maximum blade diameter in the magazine (horizontal)	mm	250
Maximum tool length in the magazine	mm	180
Device to measure tool length		optional

Tool lubrication

Minimum quantity lubrication		standard
Lubrocooling with minimum use of water-oil + dedicated tank		optional
Additional Flowdrill lubrication system		optional
X FLOW (automatic orientation of lubrication nozzles)		1 standard + 1 optional (FOM PATENT)
2 nozzles integrated into the head		standard

Chips, waste and fumes removal

Base shape optimised to collect chips and waste	FOM PATENT	standard
Chip and waste collection in base		standard
Hinged belt conveyor with ramp		optional
Integral guard system (top side)		optional

Control and software

Wired push button strip		standard
Processor		Intel i7
Movable control console		standard
24" screen		standard
Luminous FOM logo indicating the machine status		standard
USB ports		1 console + 2 in the PC
SSD		128 GB
Memory		8 GB
Wireless bar-code reader		optional
Software		Windows 10 - FST CAM 4
Lola ready		standard

Possible work area configurations (on request):

SINGLE WORKING AREA 2 PIECES AND OVERSIZED PROFILES MACHINING:

- Right pneumatic fixed stop
- Tunnel for oversized profile machining
- SW to manage oversized machining operations

SINGLE WORKING AREA 2 PIECES MACHINING WITH X PAL FOR FMC 440:

- LED bar
- SW for profile positioning
- SW to view machining cycle progress
- Device to measure profile length
- "Clock" time calculation module program user license

SINGLE WORKING AREA 2 PIECES MACHINING WITH X PAL for FMC 470:

- LED bar
- SW for profile positioning
- SW to view machining cycle progress
- Device to measure profile length
- "Clock" time calculation module program user license

PENDULAR (2 working areas, 2 pieces) AND OVERSIZED PROFILES MACHINING for FMC 440:

- Second X FLOW
- Right pneumatic fixed stop
- Software to manage pendular machining
- Safety devices for pendular machining
- Tunnel for oversized profile machining
- SW to manage oversized machining operations

PENDULAR (2 working areas, 2 pieces) AND OVERSIZED PROFILES MACHINING for FMC 470:

- Second X FLOW
- Right pneumatic fixed stop
- Software to manage pendular machining
- Safety devices for pendular machining
- Tunnel for oversized profile machining
- SW to manage oversized machining operations

MULTI-PIECE PENDULAR (2 working areas, 4 pieces) AND OVERSIZED PROFILES MACHINING for FMC 440:

- Two pairs of additional vices with independent positioning
- Transformation of std vices into vices with independent positioning
- Pair of independent motor driven mobile stops
- Second X FLOW
- Right pneumatic fixed stop
- SW to manage pendular machining
- Safety devices for pendular machining
- Tunnel for oversized profile machining
- SW to manage oversized machining operations

MULTI-PIECE PENDULAR (2 working areas, 4 pieces) AND OVERSIZED PROFILES MACHINING for FMC 470:

- Two pairs of additional vices with independent positioning
- Transformation of std vices into vices with independent positioning
- Pair of independent motor driven mobile stops
- Second X FLOW
- Right pneumatic fixed stop
- SW to manage pendular machining
- Safety devices for pendular machining
- Tunnel for oversized profile machining
- SW to manage oversized machining operations

MULTI-PIECE PENDULAR (2 working areas, 4 pieces) AND OVERSIZED PROFILES MACHINING for FMC 470:

- Three pairs of additional vices with independent positioning
- Transformation of std vices into vices with independent positioning
- Pair of independent motor driven mobile stops
- Second X FLOW
- Right pneumatic fixed stop
- SW to manage pendular machining
- Safety devices for pendular machining
- Tunnel for oversized profile machining
- SW to manage oversized machining operations

MULTI-PIECE PENDULAR (2 working areas, 4 pieces) AND OVERSIZED PROFILES MACHINING WITH X PAL for FMC 440:

- Two pairs of additional vices with independent positioning
- Transformation of std vices into vices with independent positioning
- LED bar
- Software for profile positioning
- Software to view machining cycle progress
- Device to measure profile length
- Second X FLOW
- Right pneumatic fixed stop
- Software to manage pendular machining
- Safety devices for pendular machining
- Tunnel for oversized profile machining
- SW to manage oversized machining operations
- "Clock" time calculation module program user license

MULTI-PIECE PENDULAR (2 working areas, 4 pieces) AND OVERSIZED PROFILES MACHINING WITH X PAL for FMC 470:

- Two pairs of additional vices with independent positioning
- Transformation of std vices into vices with independent positioning
- LED bar
- Software for profile positioning
- Software to view machining cycle progress
- Device to measure profile length
- Second X FLOW
- Right pneumatic fixed stop
- Software to manage pendular machining
- Safety devices for pendular machining
- Tunnel for oversized profile machining
- SW to manage oversized machining operations
- "Clock" time calculation module program user license

SINGLE WORKING AREA 2 PIECES MACHINING WITH X PAL AND OVERSIZED PROFILES MACHINING FOR FMC 440:

- LED bar
- SW for profile positioning
- SW to view machining cycle progress
- Device to measure profile length
- "Clock" time calculation module program user license
- Right pneumatic fixed stop
- Tunnel for oversized profile machining
- SW to manage oversized machining operations

SINGLE WORKING AREA 2 PIECES MACHINING WITH X PAL AND OVERSIZED PROFILES MACHINING FOR FMC 470:

- LED bar
- SW for profile positioning
- SW to view machining cycle progress
- Device to measure profile length
- "Clock" time calculation module program user license
- Right pneumatic fixed stop
- Tunnel for oversized profile machining
- SW to manage oversized machining operations

Optionals:

- Additional charge for electrical version UL-CSA
- Additional charge for EAC (Eurasian Conformity) certification
- Electric cabinet cooling
- Second X FLOW
- Pair of additional vices with longitudinal positioning through the travelling column
- Transformation of standard vices to vices with independent positioning
- Pair of additional vices with longitudinal independent positioning (on FMC 440 max 2 additional vice pairs and on FMC 470 max 3 additional vice pairs)
- UPS (Uninterrupted Power Supply) to allow PC switch-off in the event of a blackout
- Software licence for LOLA
- TOOL SET TYPE A1/HSK F63:
 - N° 1 single flute milling cutter \varnothing 5 L=50 mm (HZ-43794)
 - N° 1 single flute milling cutter \varnothing 8 L=63 mm (HZ-43796)
 - N° 1 single flute milling cutter \varnothing 10 L=90 mm (HZ325308)
 - N° 3 collet holder H=70 HSK F63 (DR-714245)
 - N° 1 collet \varnothing 9/10 ER 32 (DR-75901)
 - N° 1 collet \varnothing 7/8 ER 32 (DR-75899)
 - N° 1 collet \varnothing 4/5 ER 32 (DR-75896)
- TOOL SET TYPE A2/HSK F63:
 - N° 1 single flute milling cutter \varnothing 8 L=63 mm (HZ-43796)
 - N° 1 single flute milling cutter \varnothing 10 L=90 mm (HZ325308)
 - N° 1 single flute drill bit hss cutter \varnothing 3 L=61 mm (HZ-76292)
 - N° 1 single flute milling cutter \varnothing 6 L=60 mm (HZ-43792)
 - N° 1 double flute milling cutter \varnothing 10 L=110 mm (HZ302415)
 - N° 1 double diam. drill bit hss \varnothing 12/6 L=83 mm (HZ-39024)
 - N° 6 collet holder H=70 HSK F63 (DR-714245)
 - N° 1 collet \varnothing 2/3 ER 32 (DR-75894)
 - N° 1 collet \varnothing 5/6 ER 32 (DR-75897)
 - N° 1 collet \varnothing 7/8 ER 32 (DR-75899)
 - N° 3 collet \varnothing 9/10 ER 32 (DR-75901)
- TOOL SET TYPE A3/HSK F63:
 - N° 1 single flute drill bit HSS \varnothing 3,2 L=57 mm (HZ-78782)
 - N° 1 single flute milling cutter \varnothing 5 L=50 mm (HZ-43794)
 - N° 1 single flute milling cutter \varnothing 6 L=60 mm (HZ-43792)
 - N° 1 single flute milling cutter \varnothing 8 L=63 mm (HZ-43796)

- N° 1 single flute milling cutter \varnothing 10 L=90 mm (HZ325308)
- N° 1 double flute milling cutter \varnothing 10 L=110 mm (HZ302415)
- N° 1 double diam. milling cutter \varnothing 12/6 L=83 mm (HZ-39024)
- N° 1 single flute milling cutter \varnothing 14 L=100 mm (HZ-45257)
- N° 8 collet holder H=70 HSK F63 (DR-714245)
- N° 1 collet \varnothing 3/4 ER 32 (DR-75895)
- N° 1 collet \varnothing 4/5 ER 32 (DR-75896)
- N° 1 collet \varnothing 5/6 ER 32 (DR-75897)
- N° 1 collet \varnothing 7/8 ER 32 (DR-75899)
- N° 3 collet \varnothing 9/10 ER 32 (DR-75901)
- N° 1 collet \varnothing 13/14 ER 32 (DR-76047)
- • Double tool 90° angular head unit
- Spindle connection flange
- • Angular head unit for vertical blade
- \varnothing 230 mm blade
- Spindle connection flange
- • Horizontal blade assembly cone
- Blade \varnothing 250 mm
- Machine handling by container